

局部腐食とその防止方法

Local Corrosion and Its Protection

SECRET

[REDACTED]

[REDACTED]

[REDACTED]

SECRET

↑

×

□

■

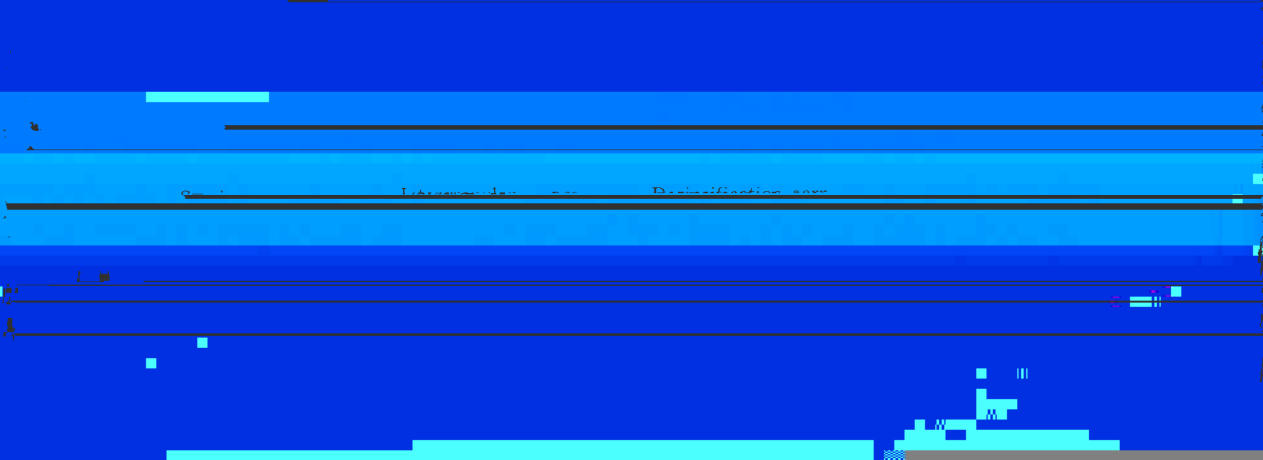
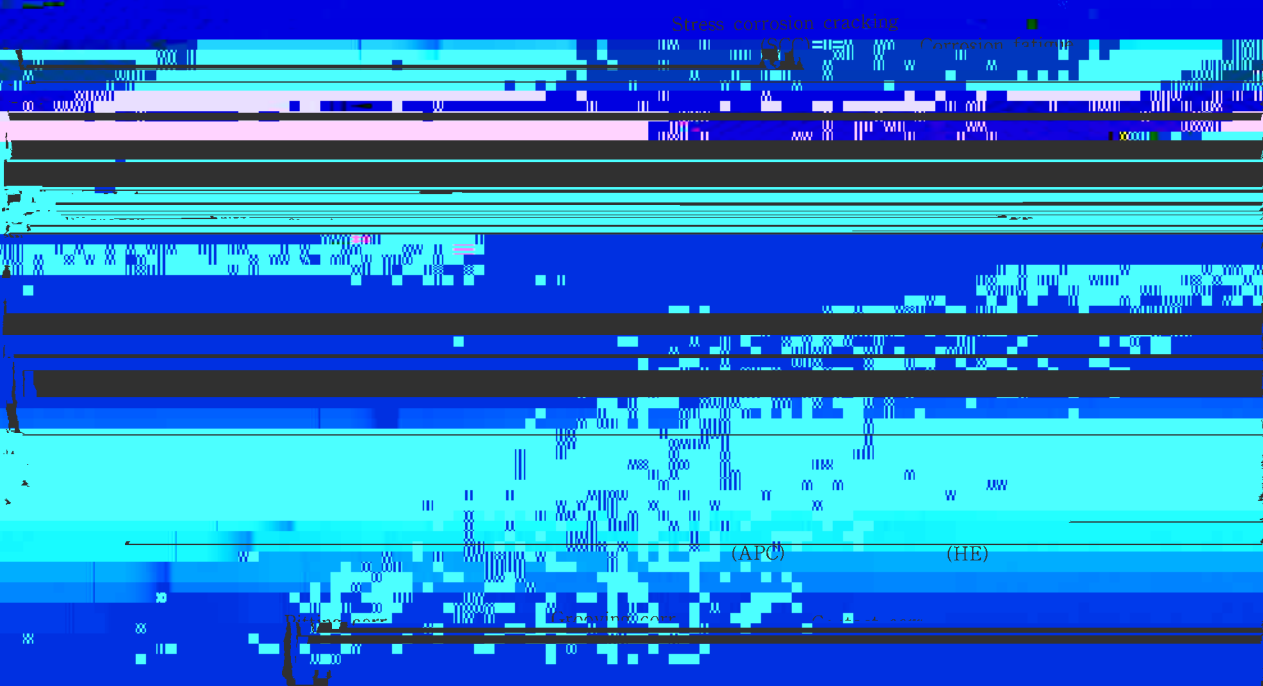
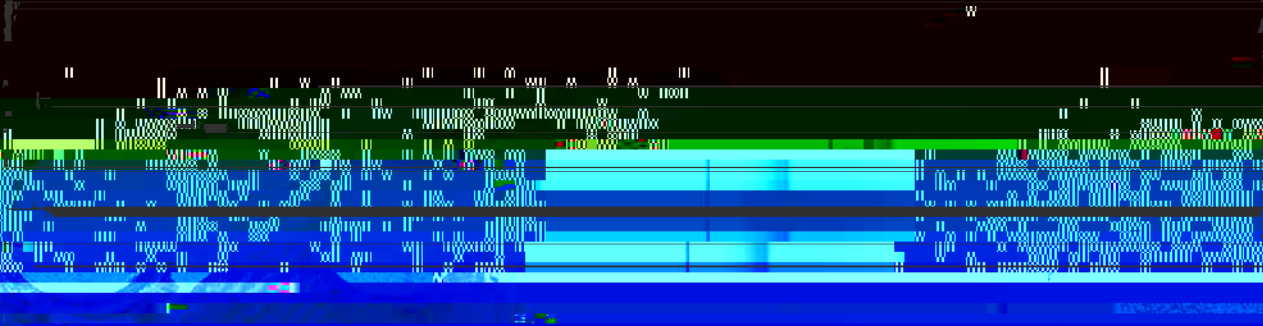
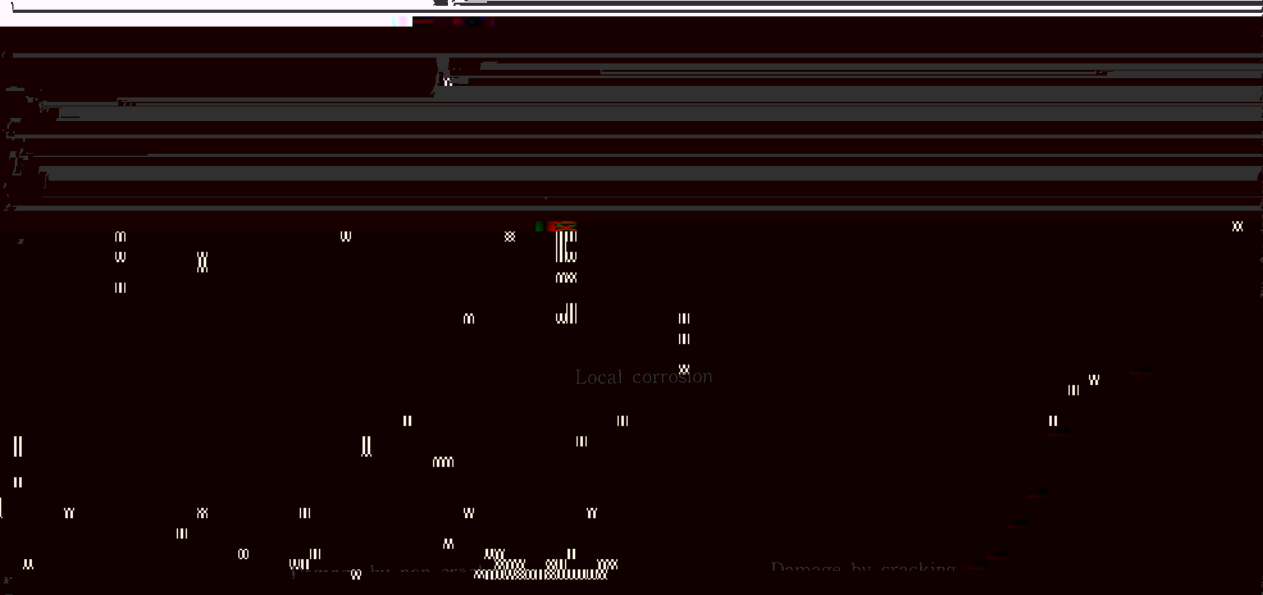

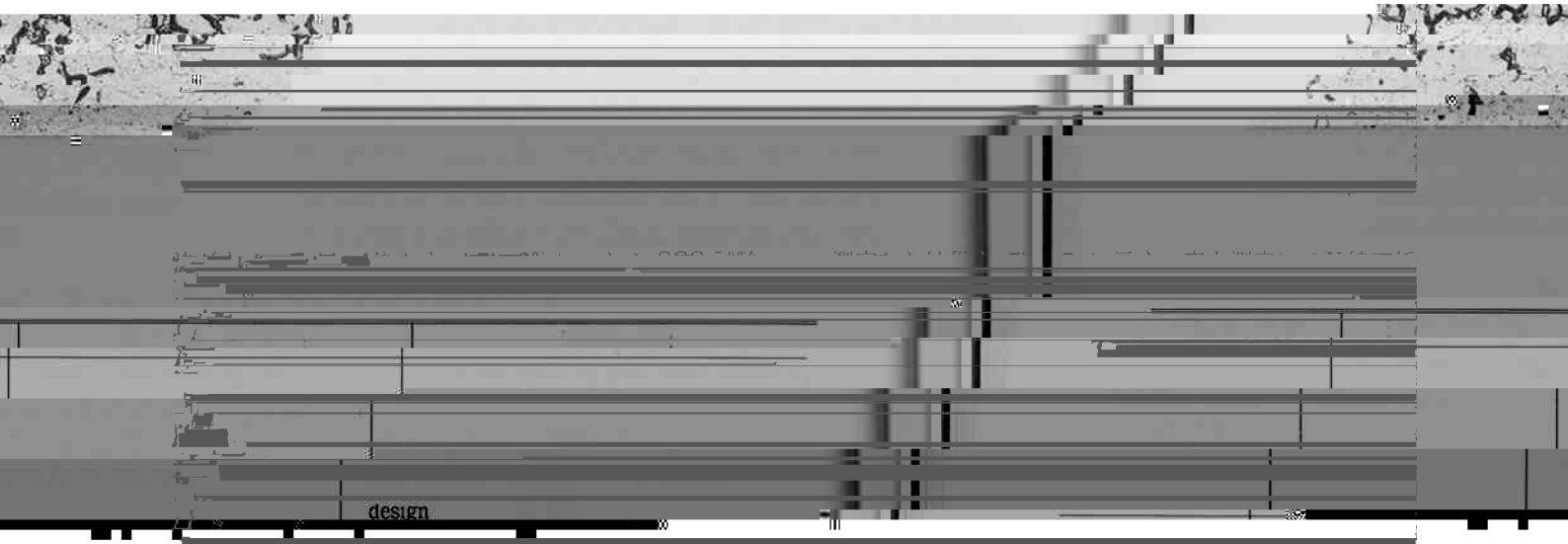

design

(Photo 4)

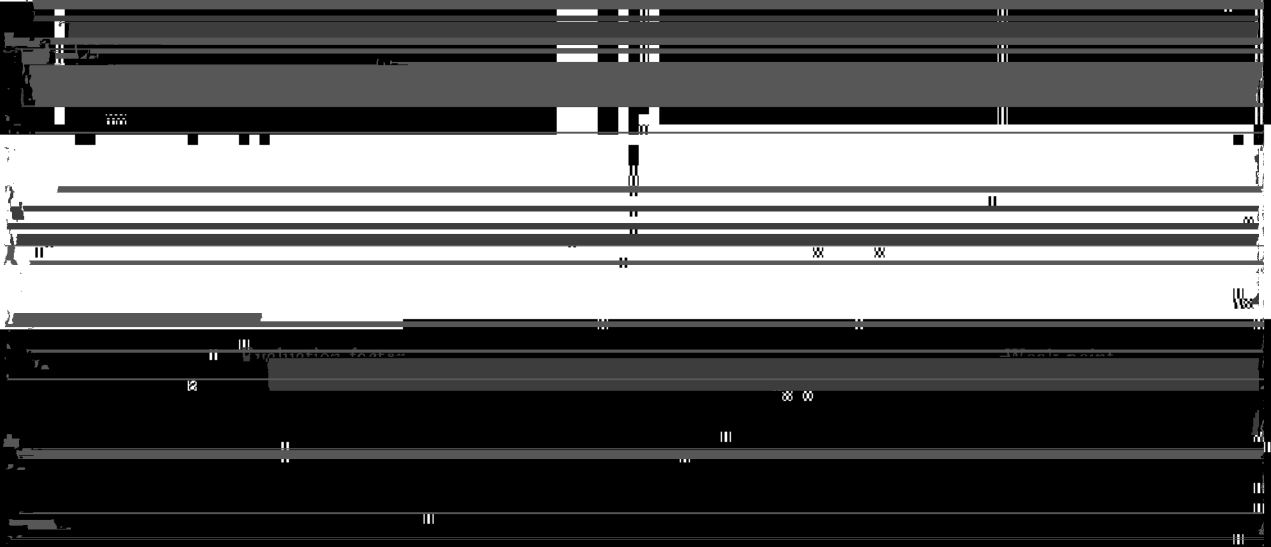

96

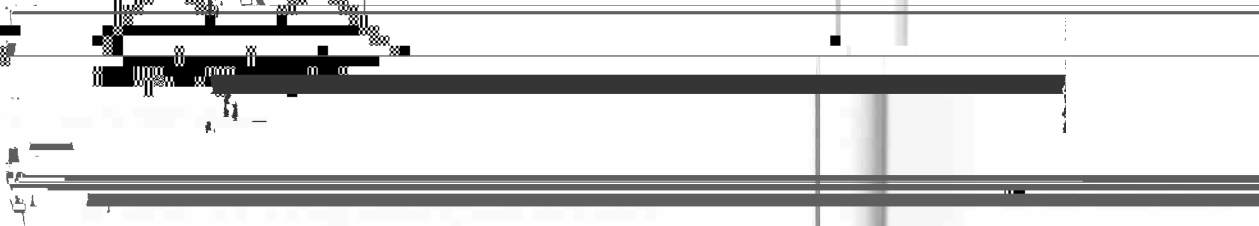
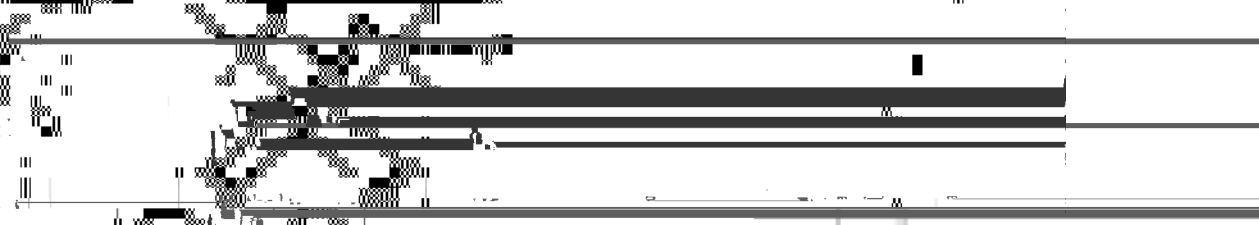
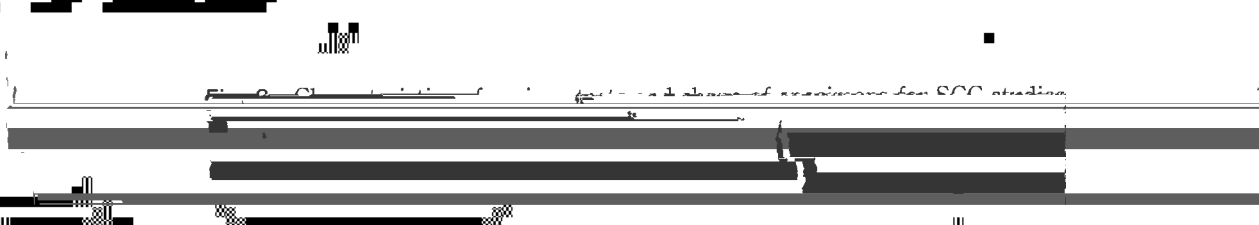
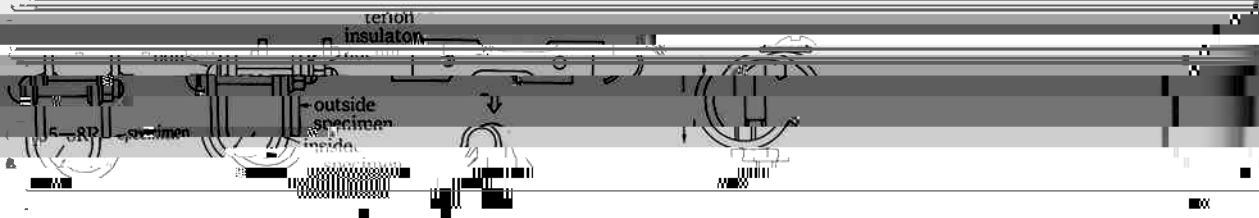

[REDACTED]

[REDACTED]

[REDACTED]

[REDACTED]

[REDACTED]

[REDACTED]

[REDACTED]

[REDACTED]

[REDACTED]

[REDACTED]

[REDACTED]

[REDACTED]

[REDACTED]

[REDACTED]



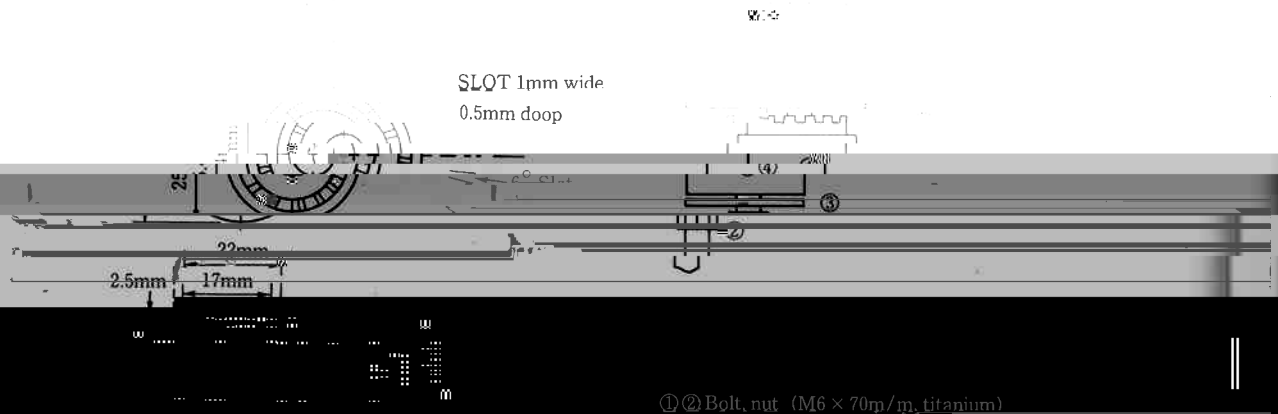

Design	ITC	ACPM	Test condition	Material	Detail
[illegible]	[illegible]	[illegible]	[illegible]	[illegible]	[illegible]

RY-TRINCO-1000

66

The table at the bottom of the page has six columns with headers: 'Design', 'ITC', 'ACPM', 'Test condition', 'Material', and 'Detail'. The rows below the header contain illegible text. Below the table, the text 'RY-TRINCO-1000' and the number '66' are visible.

